



# Cantilever Racking

Storage system for long or variable length loads





An ideal handling and storage solution for very long products

Cantilever racking are specially designed to house long or varied load units, such as metallic profiles, pipes, mouldings, wooden board, metal or plastic sheeting, etc.

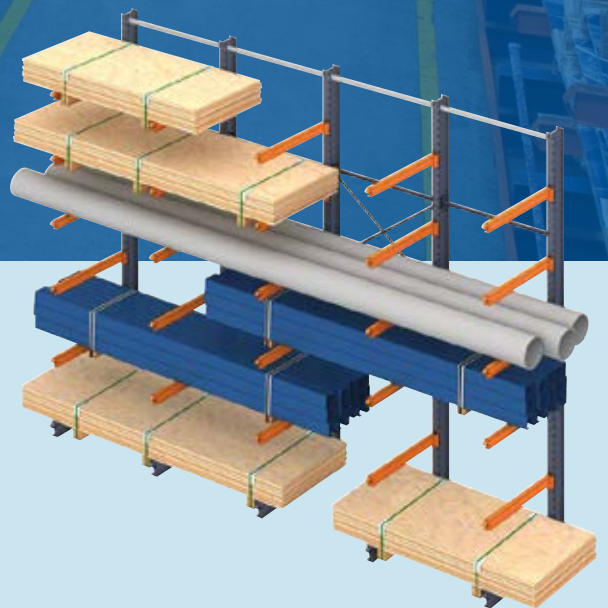

The system basically consists of vertical profiles (columns) and horizontal profiles, which are placed to provide stability, as well as overhanging arms on which the load is placed.

Loads may be handled manually when they are lightweight, or by using forklifts or other appropriate lifting systems when heavy items are involved.

# Advantages

Maximum versatility to adapt to any warehouse type and unusually sized product

## 1 Space savings

Easily configurable to adjust to different heights and types of goods.

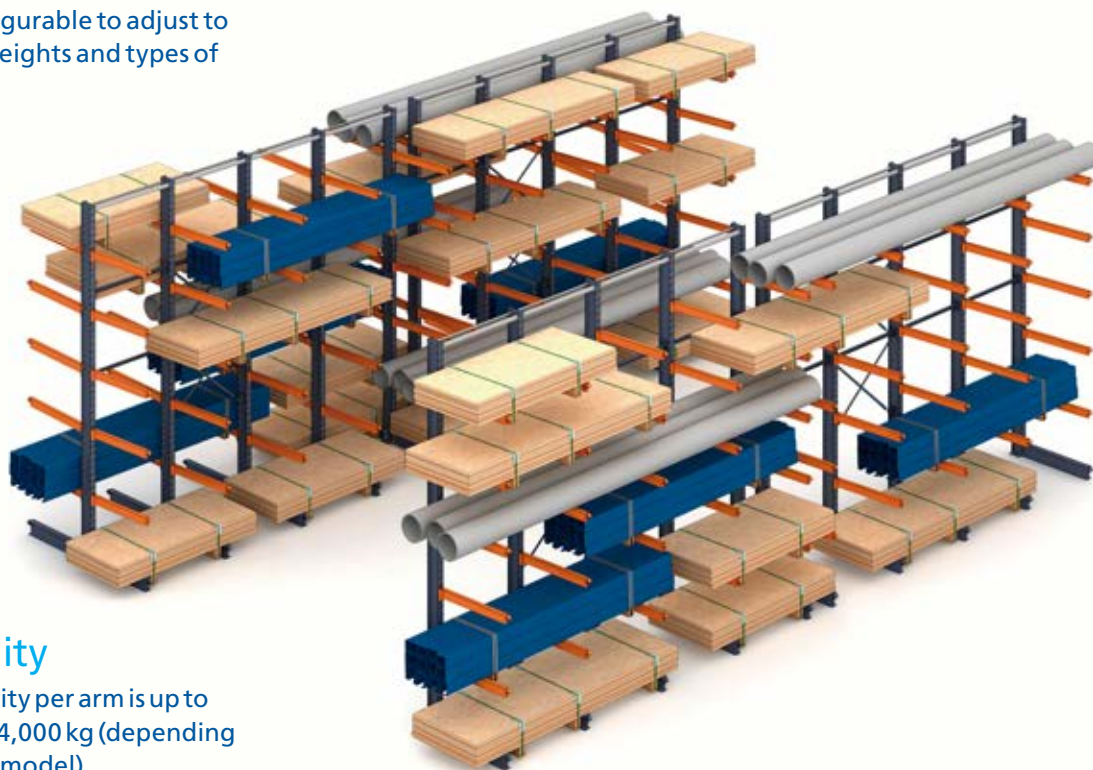

## 2 Versatility

Load capacity per arm is up to more than 4,000 kg (depending on the arm model).

## 3 Easy to assemble

Easily adjustable elements that facilitate its assembly and adaptation to future needs.

## 4 High-density

Option to install the cantilever rack on mobile bases to compact space without losing direct access to the load.

## 5 Quality

Its basic components are made out of hot-rolled profiles, which render great strength for loads and against deformations due to impacts.

## 6 Safety

It includes vertical braces, stops, safety pins, protectors for the uprights, reinforcers, etc., which guarantee its stability and durability.

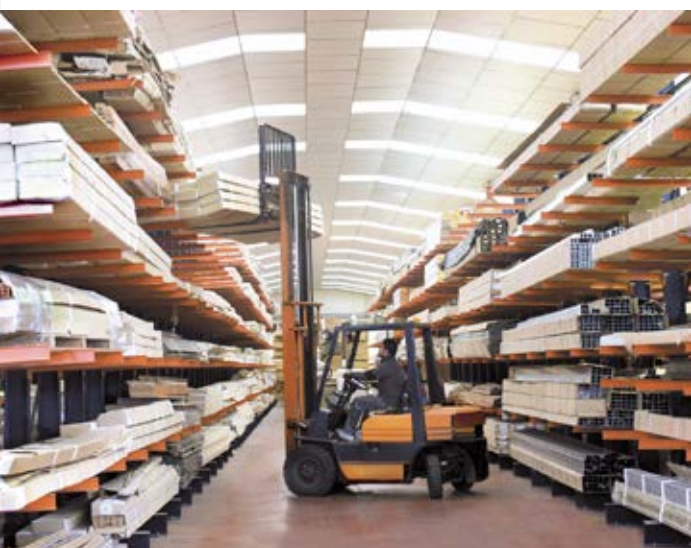

# Layout of the warehouse and loads

Distribution options that ensure the stability and safety of the installation

## Single or double racking

The warehouse is laid out with a combination of single sided cantilever racks, normally placed against walls with access from one side only, and double sided cantilever which can be accessed from both sides.



Single

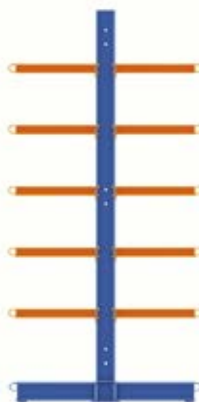

Double

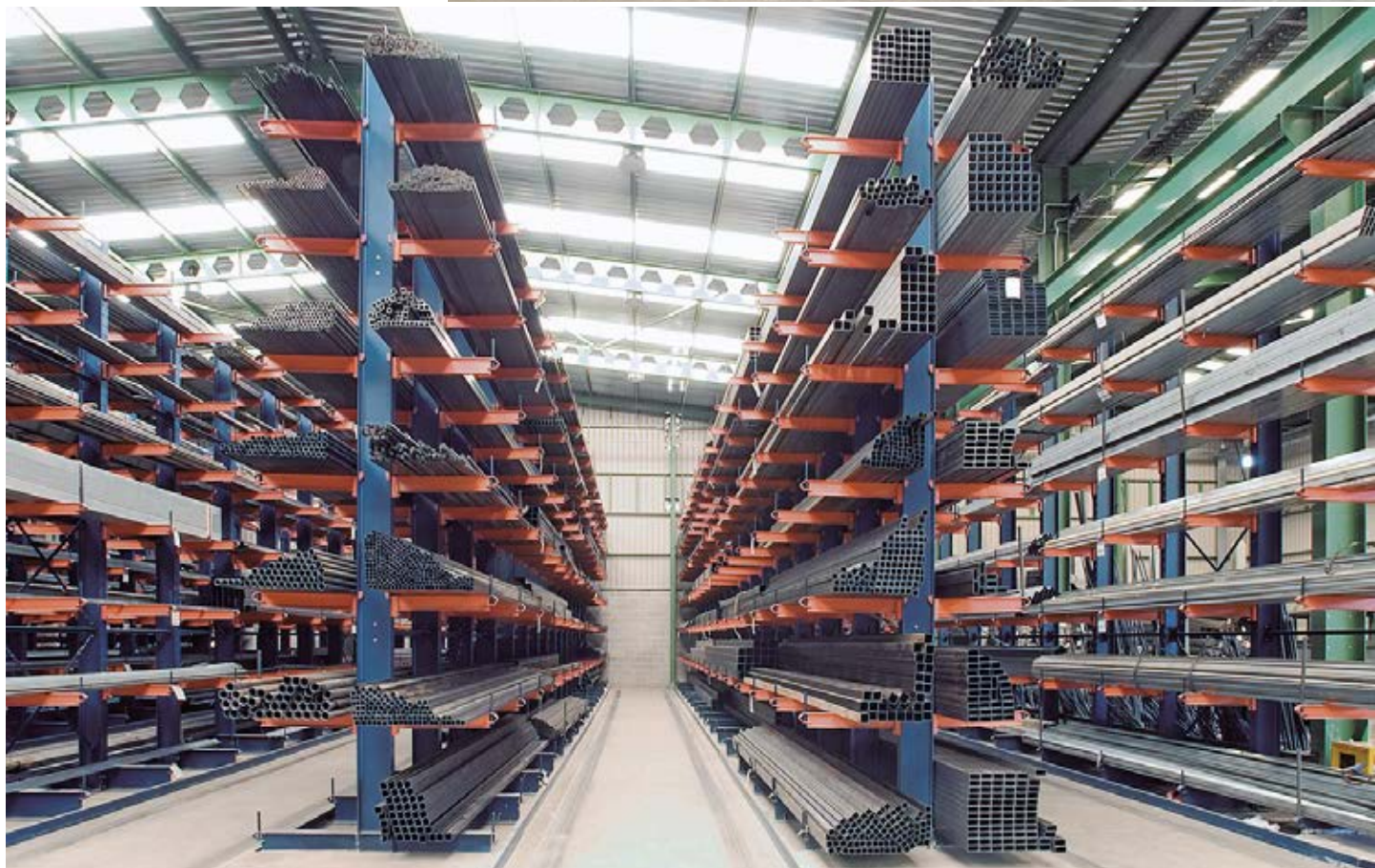

### Racking layout

For the distribution and calculation of these racks, the size, weight and rigidity of the goods, the handling equipment used (generally forklifts) and the tolerance – among other factors – must be taken into consideration.

Each load must be supported by at least two arms. Products may protrude from the sides of both arms by up to a maximum of 50% of the horizontal distance between adjacent arms. This ensures stable support and uniform load distribution.

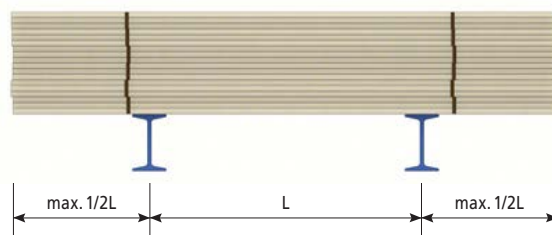
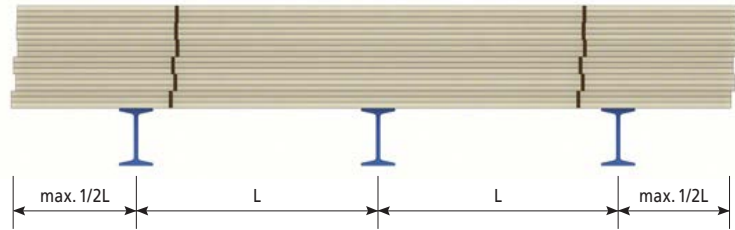

### Examples of the most common distributions (dimensions in mm)

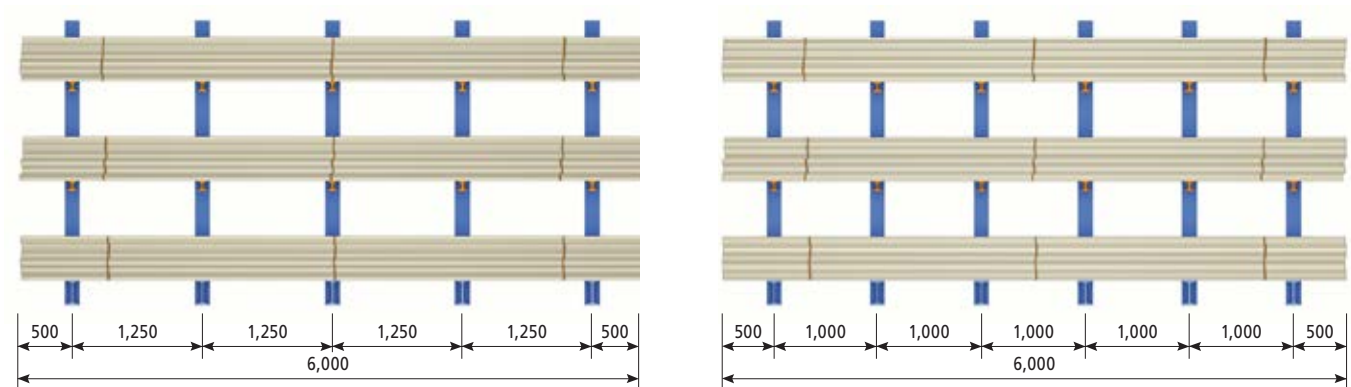
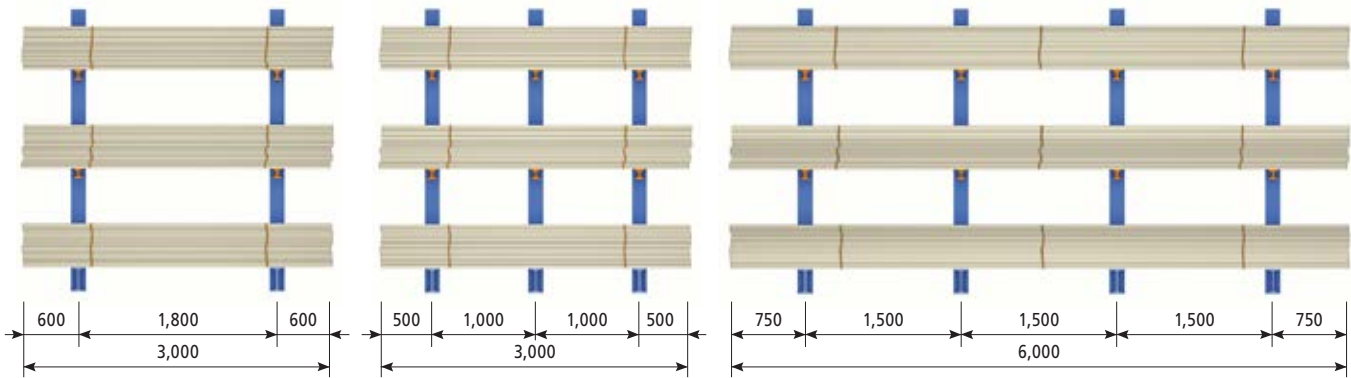

The optimal number of columns to guarantee the resistance and stability of the installation can vary based on the weight and rigidity of the goods, although their length may be the same.

# Components

Columns and arms that offer customised support according to the load type



The cantilever racking system consists of different hot-rolled metal profiles developed by Mecalux, with thicknesses and sizes that encompass all market requirements: columns and arms for light, medium or heavy loads. In order to choose the most suitable system, in addition to the load weight, the size of the goods and

the height of the rack itself must also be considered.

Thus, the cantilever system is suitable both for manually handled loads and those that require the aid of mechanical or automatic equipment, from forklifts to bridge or stacker cranes.

All their components are modular and fit together easily, allowing quick assembly and great mobility. Longitudinal stability is obtained by means of bracing sets and joining all the columns of the same rack together.



1. Column
2. Base
3. Arm
4. Arm stop
5. Cross bracing
6. Bracing set
7. Shim plate
8. Anchoring
9. Safety pin

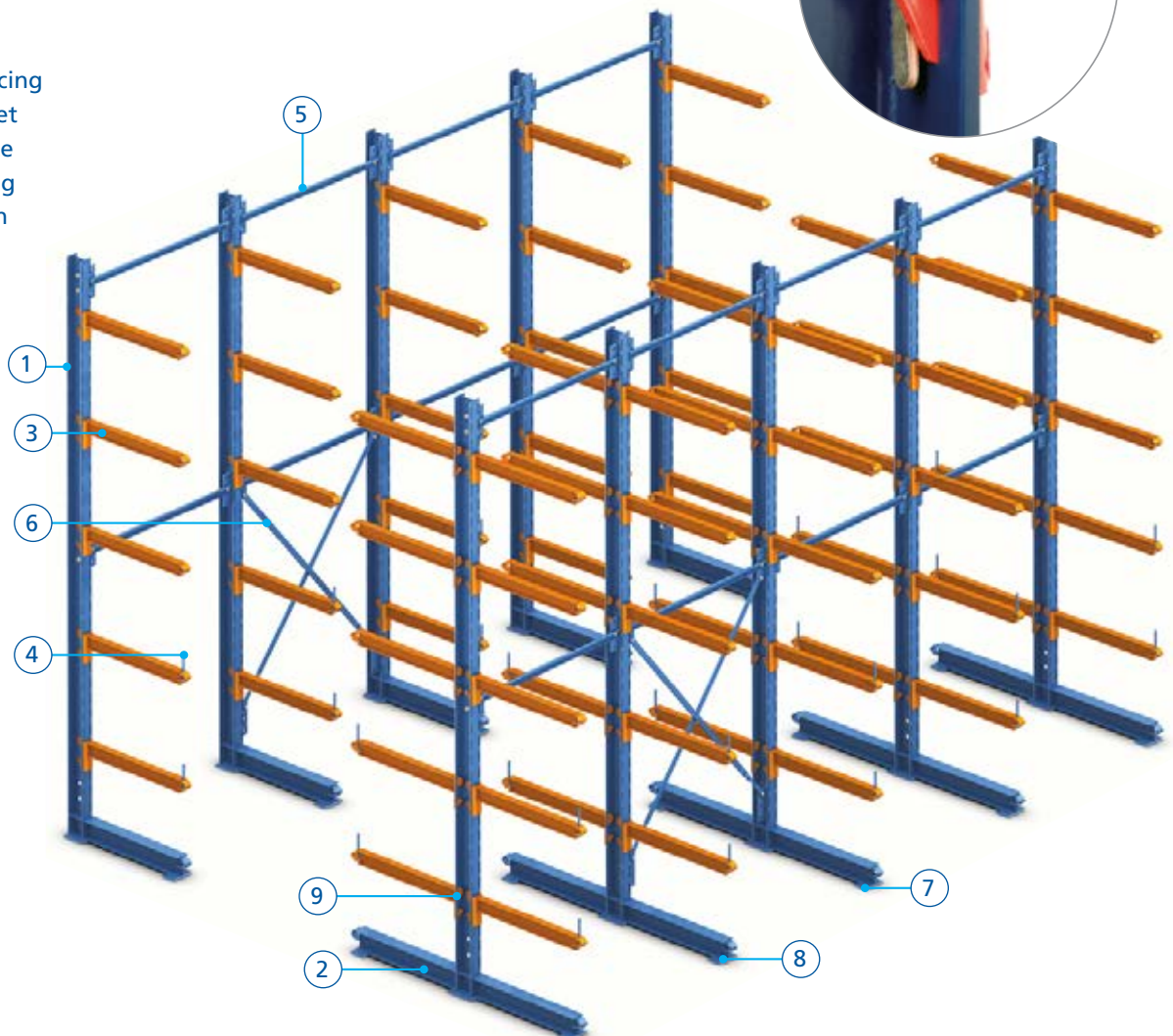



## Columns

They are made of hot-rolled profiles, with thicknesses that vary depending on the load they must support. The columns are usually formed by single profiles. Although if needed, two profiles can be joined together, considerably increasing their load-bearing capacity.

The slots on the columns designed to attach arms using either hooks or bolts, which makes the calibration of its height possible. There are also attachment points for crossbars and braces.

The standard height of the columns ranges between 2 and 7.5 m, although it is possible to manufacture other sizes based on the requirements of the client.



Single column

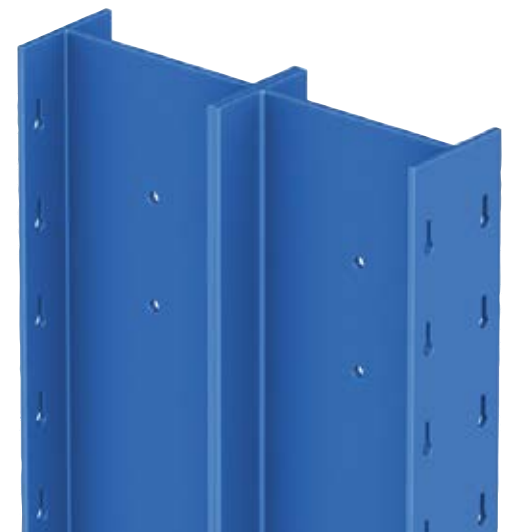

Double column



## Bases

They are joined to the columns via a fixing plate that is welded to the end of the base. This allows correct support and easy levelling of the racks. In addition, bases have holes for the placement of floor anchors. The fronts of the bases include protectors and the possibility of adding stops when it is required to facilitate the placement of the load.

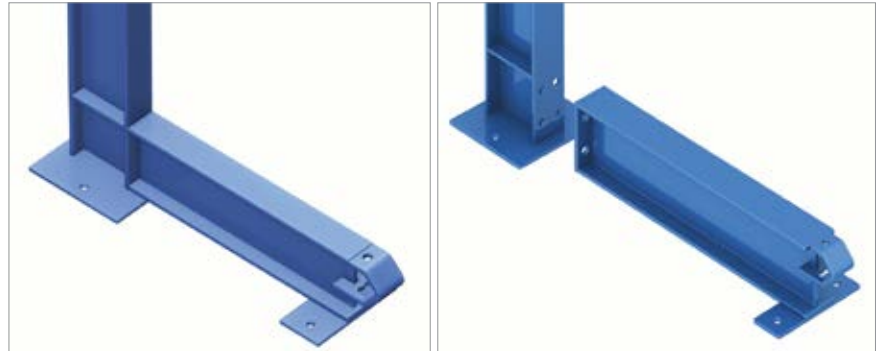



## Arms

These are manufactured from hot-rolled profiles whose geometry and dimensions may vary based on the load which they must support.

Attaching arms to the column may be done using hooks or by bolting them. This all depends on the characteristics of the installation, the loading and unloading method, or the load required.

All arms have a guide on the load input end, which helps the operator to place the goods. In addition, they are always placed on a slight incline to avoid the possibility of loads falling.

These arms may be equipped with stops as an additional safety measure to avoid loose loads from falling, as well as cross-ties, which make it possible to set up shelves for a wide variety of load sizes.

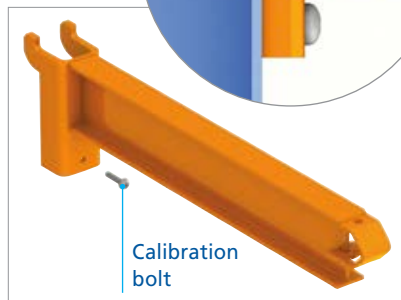

Arm with hooks

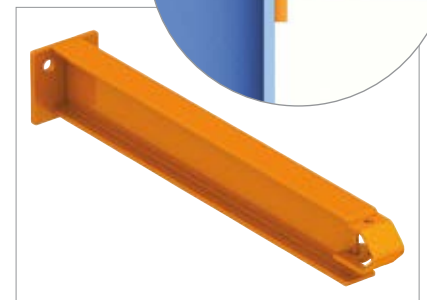

Bolted arms



## Stops

Optional elements that are especially useful for the storage of loose loads, preventing them from falling. Formed by a round tube and a plastic protective plug, which are inserted into the upper hole located at the ends of the arms, and fit into the lower tab.

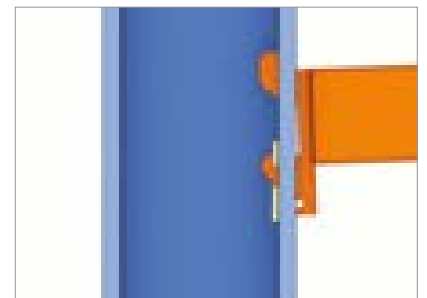

## Safety pins

These prevent arms from accidentally slipping out of place when they are attached using hooks.



### Rigidifying elements

In order to rigidify the racks lengthwise, bracing sets with tensors and column cross-braces are used. These join all the columns together, constituting a solid and stable structure.

# Accessories

## Elements that increase installation safety

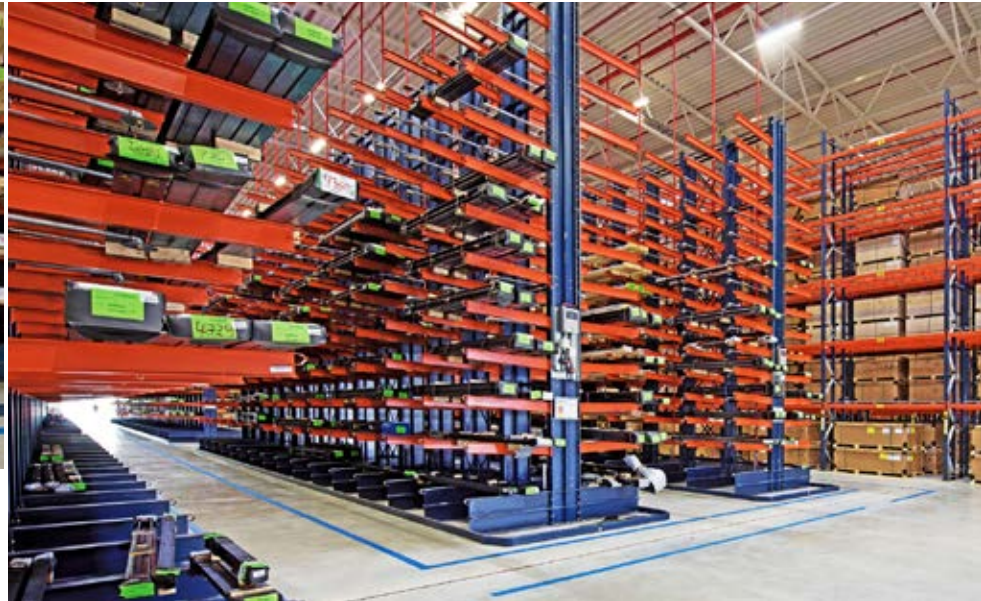
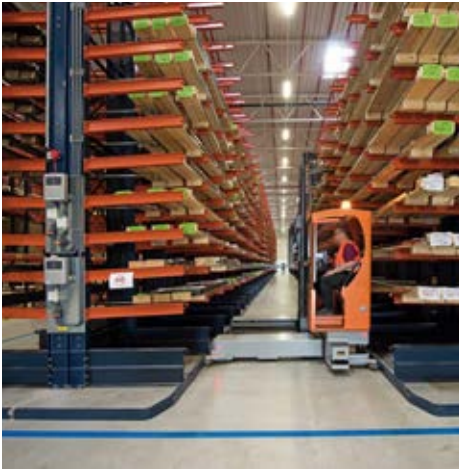

### Forklift guides

The most ideal forklifts for working with cantilever racking are four-way side-loading types, which can handle load packages up to 12 m long. These forklifts need lateral guides placed in the load aisles in order to safely circulate.

The distance between the guides and the loads depends on the forklift model.



Detail of the profile used for guides.

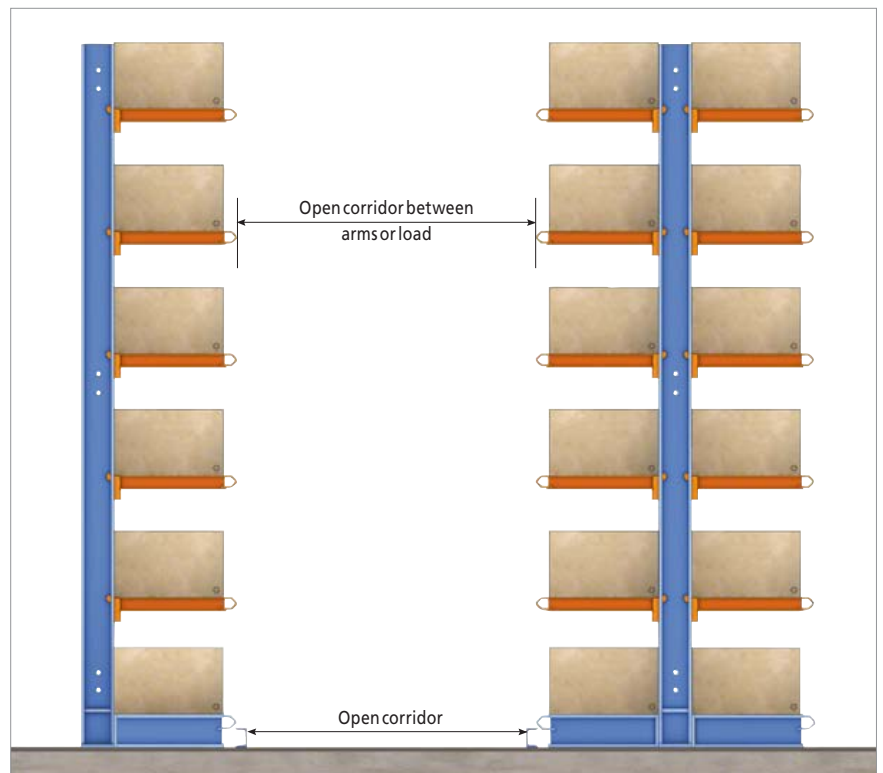

### Guide entrances

The guides at the beginning of each aisle have entrances that facilitate the entry of the forklift.

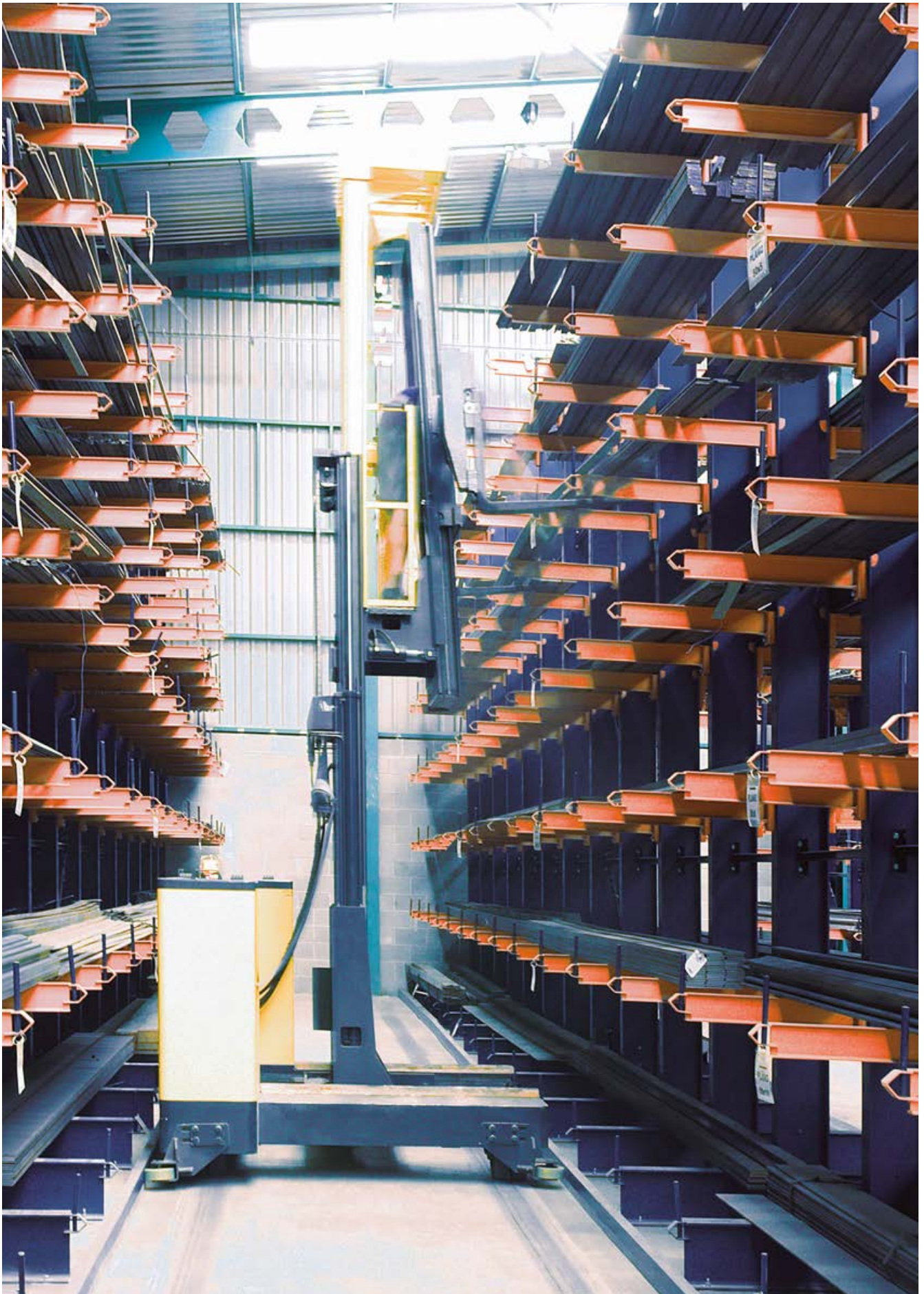



### Protective elements

When there are no guides, protectors can be placed, saving the racks from possible blows.



### Shelving

If one needs to store small and variable sized packages, the best solution is to install continuous shelving on top of the cantilever arms. This solution takes full advantage of the space and does not leave empty gaps.

Shelves can be made out of wood or metal shelves according to the needs of each warehouse.

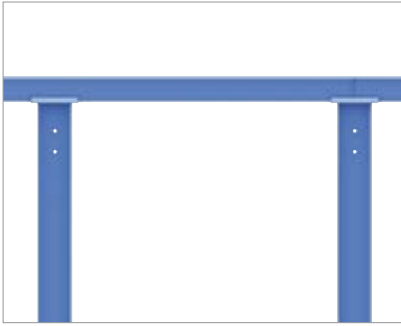

### Portico crossbars

When the racks require it, portico crossbars are installed, joining the racks together from top to bottom, and rendering them very stable.



### Signalling plates

These are signs that list the technical characteristics of the installation.

They are placed in visible areas at the far ends of the installation.

# Uses

From wood planks to the configuration of a building's structure



Mecalux has developed a basic range of three Cantilever racking systems to cover all market needs:

**Light duty cantilever racking**, for the manual storage of loads.

**Medium duty cantilever racking**, for mechanically handled medium weight loads.

**Heavy duty cantilever racking**, for heavy loads manoeuvred by both automatic or mechanical handling systems.

These images show the diversity of the load units found in the cantilever system. It is the best handling and storage choice for: plastic tubes, wooden planks or wrapped metal profiles.







Example of automated cantilever racking with a bridge crane that connects the production and storage zones.





### Cantilever on mobile bases

To increase the capacity of available space, cantilever racking can be installed on mobile bases.

The bases are wheeled structures, moved by integrated motors, which run along rails set into the floor. These bases include control and safety systems depending on the needs of each warehouse.

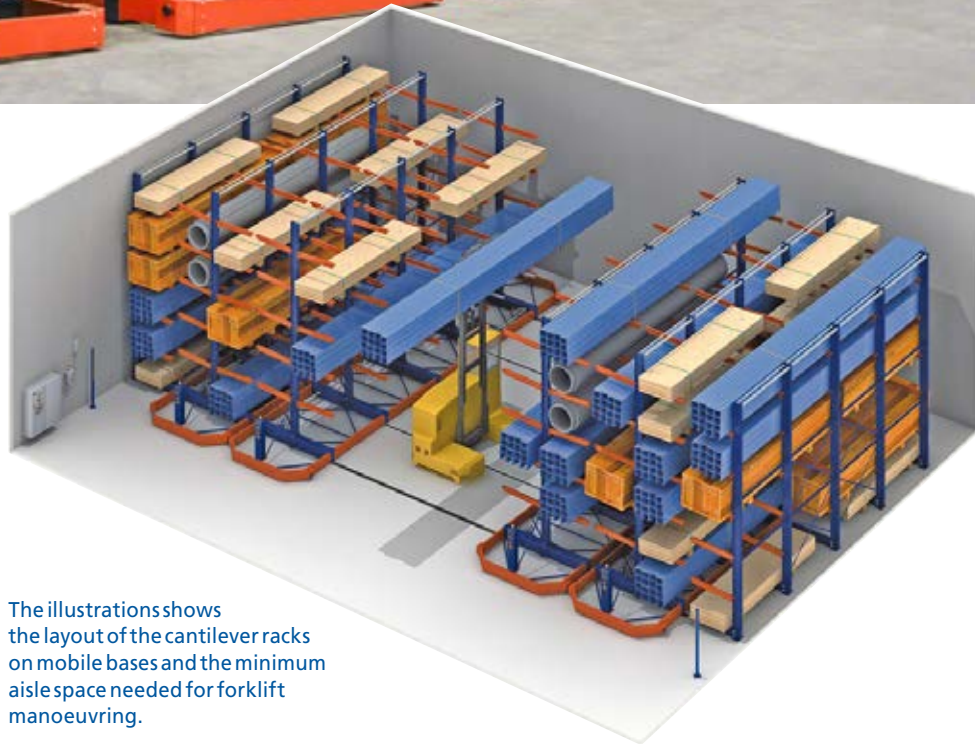

The illustration shows the layout of the cantilever racks on mobile bases and the minimum aisle space needed for forklift manoeuvring.

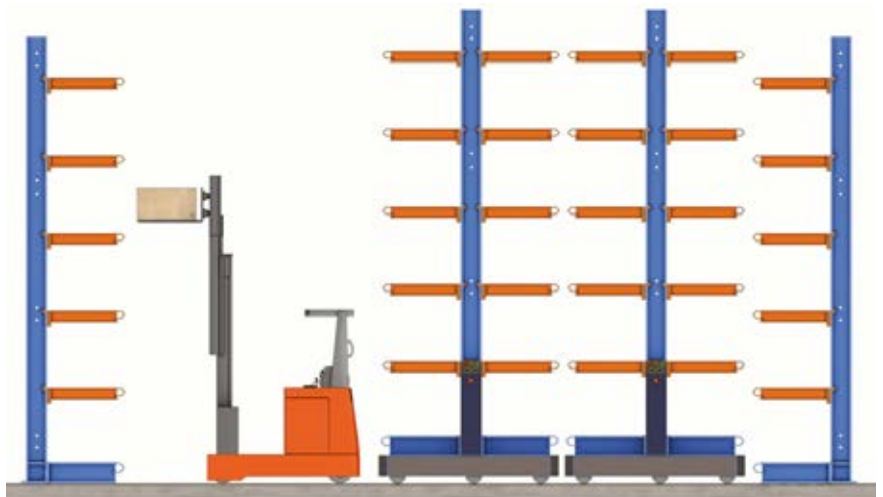





### Outdoor cantilever racking

It is common to install cantilever racks outdoor areas. In such cases, Mecalux has both the specific components to protect goods from adverse weather conditions, and various classes of light roofing.

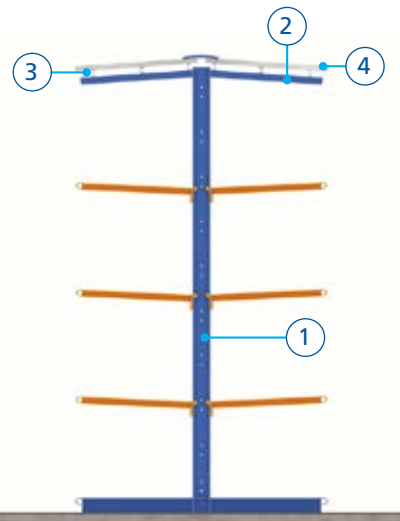
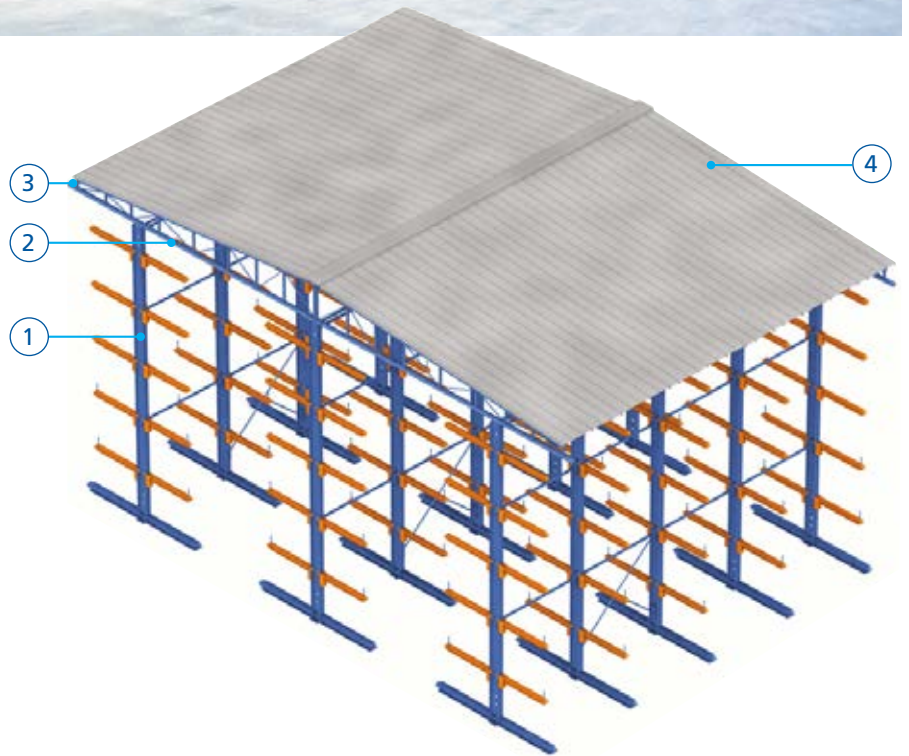

1. Whole cantilever unit
2. Portico or roof trusses
3. Roof joists
4. Cladding or roofing

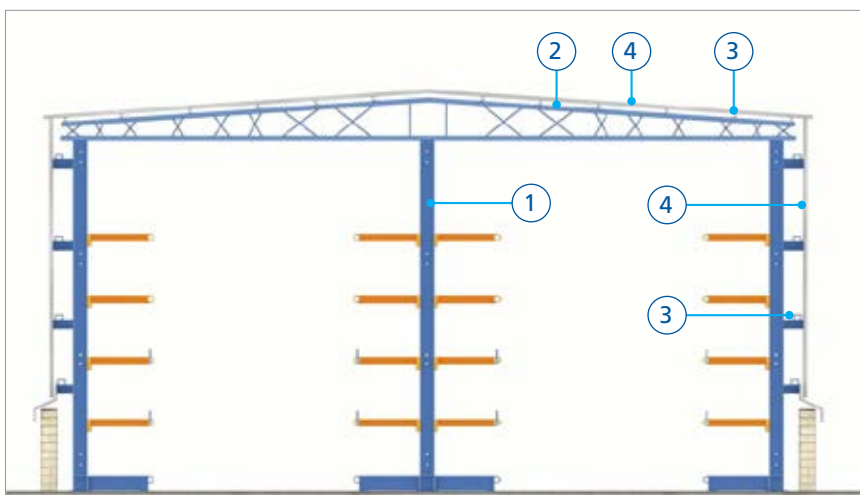

1. Whole cantilever unit
2. Portico or roof trusses
3. Roof joists
4. Cladding or roofing

### Clad-rack warehouse

Whenever it is essential to maximise the surface area and space at heights, cantilever racking can also be used to construct clad-rack warehouses.

In such cases, in addition to supporting the stored loads, the racks must also be calculated to withstand the weight of the building itself, as well as the forces of the wind, and the weight of the siding and roofing. The seismic coefficient corresponding to the area where the cantilever racks are installed must always be taken into account.

# Quality principles

Durability, strength and accurate calculations



## Painting of the cantilever

The basic components of the cantilever racking are manufactured out of hot-rolled profiles, rendering great strength for loads and protection against deformations due to impacts.

During the rolling process, profiles are covered with calamine, a layer of impurities produced on the surface of steel from heating. This layer must be properly removed before painting, in order to ensure that the paint adheres correctly, a basic requirement for rust prevention.

Chemical treatment is not sufficient to remove the calamine.

The complete process by which Mecalux treats these parts consists of three consecutive phases:

### 1. Shot-blasting

Shot-blasting consists of removing the calamine mechanically, through the high-pressure impact of small steel balls. These balls break up the calamine and remove it from the surface. They also remove any layers between the calamine and the surface of the profile, consequently preventing rust from developing.

At the same time, all dirt and the lubricant used in the machining process are removed. This leaves the piece in perfect condition and ready to be painted, ensuring the paint will adhere properly.

### 2. Painting

The automatic painting phase is carried out immediately after shot-blasting, thereby preventing rust from developing between phases.

### 3. Polymerisation

Blue acrylic (RAL 5003) paint is used, 50 microns thick and polymerised in a drying oven.

Once arms are shot-blasted, they are put through an automatic chemical descaling tunnel (to remove any possible oxidation that has formed between phases), after which they are painted with orange water-soluble paint (RAL 2001) and dried at high temperatures.

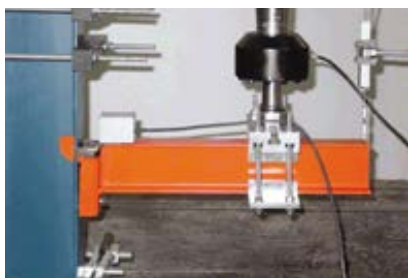

## Calculation standards

For the required cantilever racking calculations, the international calculation standards EN 15620 and RAL RG614/5 have been observed.

The joints between arms and columns have been tested beforehand using authorised laboratories and methods in order to determine the degree of embedment; this data is required for the strength calculations.

All materials used, profiles, manufacturing and assembly processes are carefully calculated, and subject to exhaustive checks and testing, which result in the highest possible levels of safety for installations, for the goods stored in them and, above all, for the people working in the warehouse.

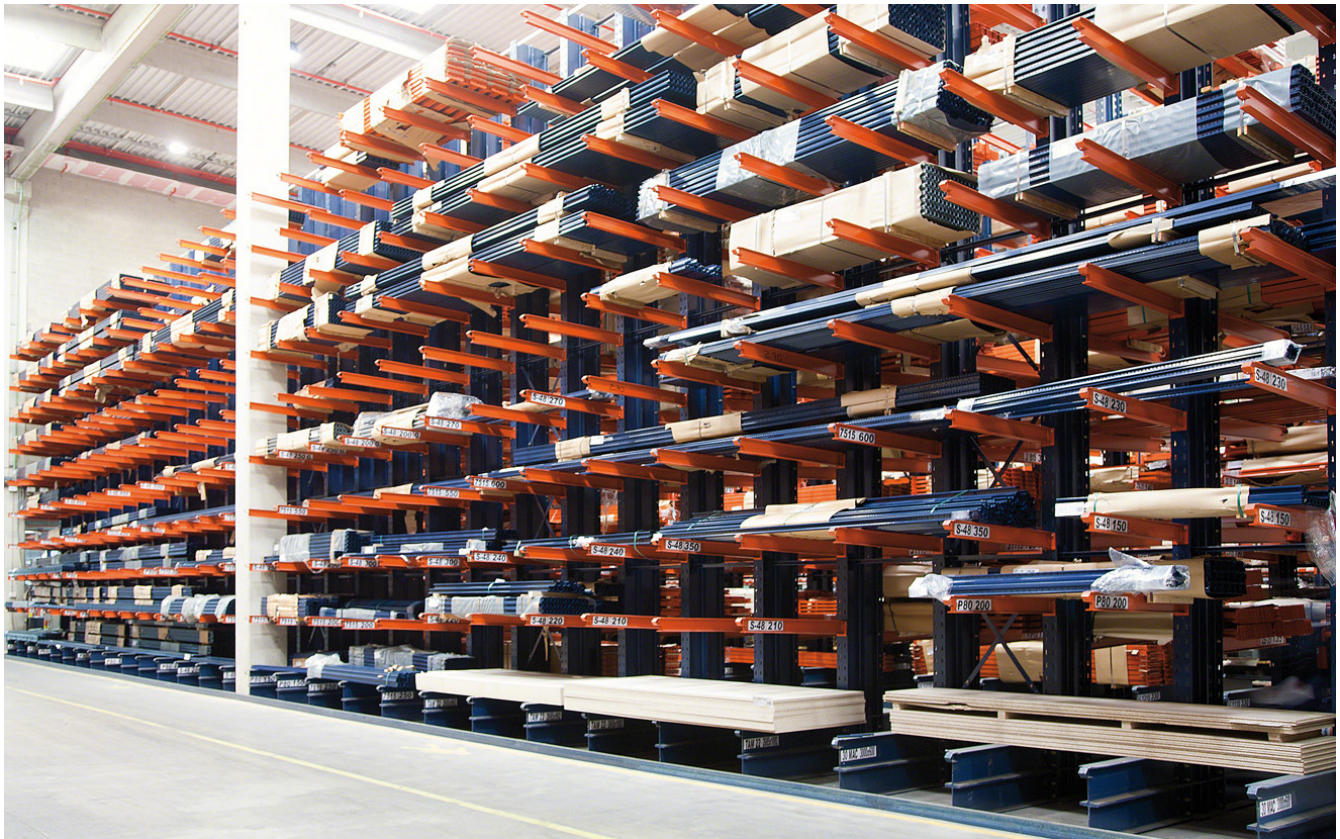

## Quality certifications



### ISO 9001

Mecalux has received the ISO 9001 quality management certificate, which is applied to the design, production, installation and after-sales service of metal racking. The ISO 9001 certificate has been awarded to the production centres in Spain, Poland, Mexico, Argentina and the USA for all static, mobile, and live metal racking, light duty racking, mezzanines, change room lockers and partitions.



### ISO 14001

Mecalux is aware of the effects the activities carried out in its work centres may have on the environment. The application of an appropriate Environmental Management System to all our activities guarantees that organisational, production and technical tasks that affect the environment are planned for, directed by and controlled in order to comply with established requirements in the ISO 14001 standard.



### ISO 45001

The prevention of occupational risks has become, at the present time, a very important factor in the day to day management of companies. In order to prevent accidents and create a safer workplace, Mecalux has received the internationally recognised ISO 45001 certification, which specifies the requisites to follow for correct occupational health and safety management.



e-mail: [info@mecalux.pl](mailto:info@mecalux.pl) - [mecalux.pl](http://mecalux.pl)

**ЗАВОД**

**ГЛИВИЦЕ**

tel.: (+48) 32-331 69 66

ul. Wyszółkowskiego 125  
44-109 Gliwice

**КОММЕРЧЕСКИЕ ОТДЕЛЫ**

**ВАРШАВА**

tel.: (+48) 22-654 56 81

e-mail: [warszawa@mecalux.com](mailto:warszawa@mecalux.com)

**КРАКОВ**

tel.: (+48) 12-686 38 70 (71)

e-mail: [krakow@mecalux.com](mailto:krakow@mecalux.com)

**ПОЗНАНЬ**

tel.: (+48) 61-665 97 87

e-mail: [poznan@mecalux.com](mailto:poznan@mecalux.com)

**ВРОЦЛАВ**

tel.: (+48) 71-793 88 29

e-mail: [wroclaw@mecalux.com](mailto:wroclaw@mecalux.com)

**ГДЫНЯ**

tel.: (+48) 58-761 80 80

e-mail: [gdansk@mecalux.com](mailto:gdansk@mecalux.com)

**Месалух присудствуе в более чем 70 странах мира**

**Офисы в:** АРГЕНТИНА - БЕЛЬГИЯ - БРАЗИЛИЯ - ЧЕХИЯ - ЧИЛИ - ФРАНЦИЯ - ИСПАНИЯ - ГОЛЛАНДИЯ - КАНАДА - КОЛУМБИЯ  
МЕКСИКА - ГЕРМАНИЯ - ПЕРУ - ПОЛЬША - ПОРТУГАЛИЯ - СЛОВАКИЯ - ТУРЦИЯ - США - ВЕЛИКОБРИТАНИЯ - ИТАЛИЯ - УРУГВАЙ

